

BUSTER + PUNCH

PULL BAR

TECH SPEC

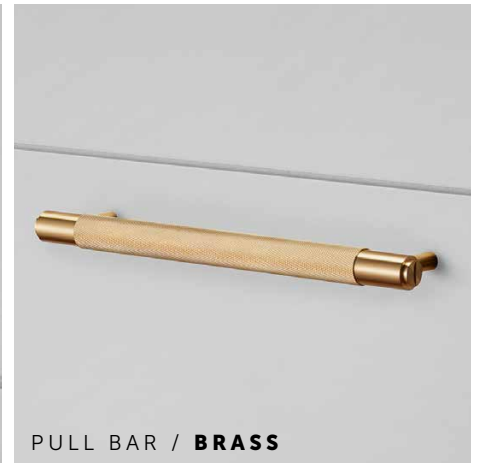

PULL BAR

A Pull Bar Handle made from solid metal. A solid bar with diamond-cut knurled handle detailing, ensuring pleasure with every touch. Works great on cabinet doors, wardrobe drawers, cupboards, kitchen units and just about anything that can open. Available in 4 metal finish combinations using brushed brass, steel, smoked bronze & satin black metal. Available complete with a rectangular plate and penny buttons or just nude.





busterandpunch.com
info@busterandpunch.com

BUSTER + PUNCH

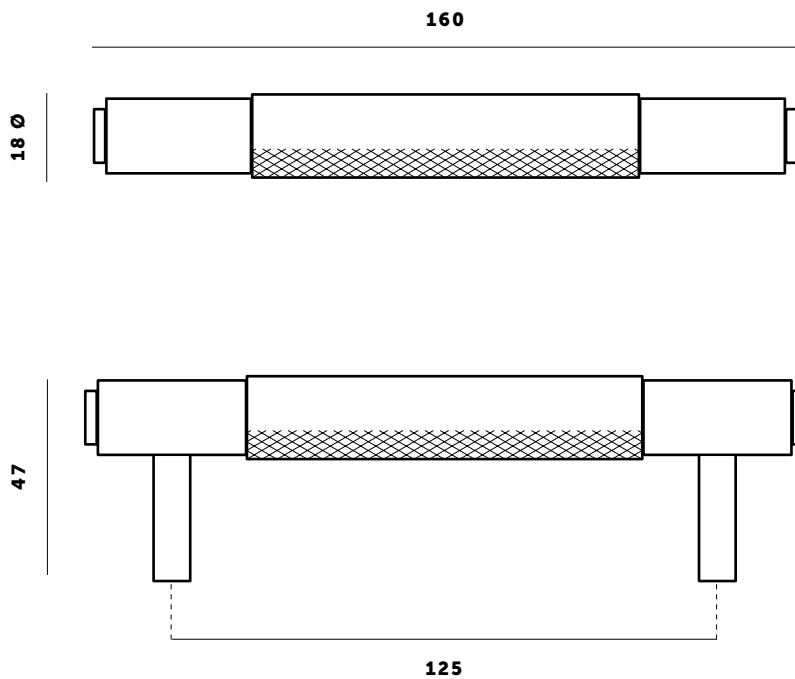
PULL BAR / SMALL

TECH SPEC



FINISH	SKU	ALSO INCLUDED:
 Steel	UK-PB-H-160-ST-A	2x M5 x 30 mm screw* 2x Washer  2 pcs 2 pcs Handle is fitted from behind cabinet door and can not be front face fitted.
 Brass	UK-PB-H-160-BR-A	
 Smoked Bronze	UK-PB-H-160-SM-A	
 Black	UK-PB-H-160-BL-A	

CARE INSTRUCTIONS

Wipe with damp cloth with no loose hairs, avoid using any chemicals. Please note all finishes are prone to aging.

* Fits doors & draws of max 20 mm.



PULL BAR / MEDIUM
TECH SPEC

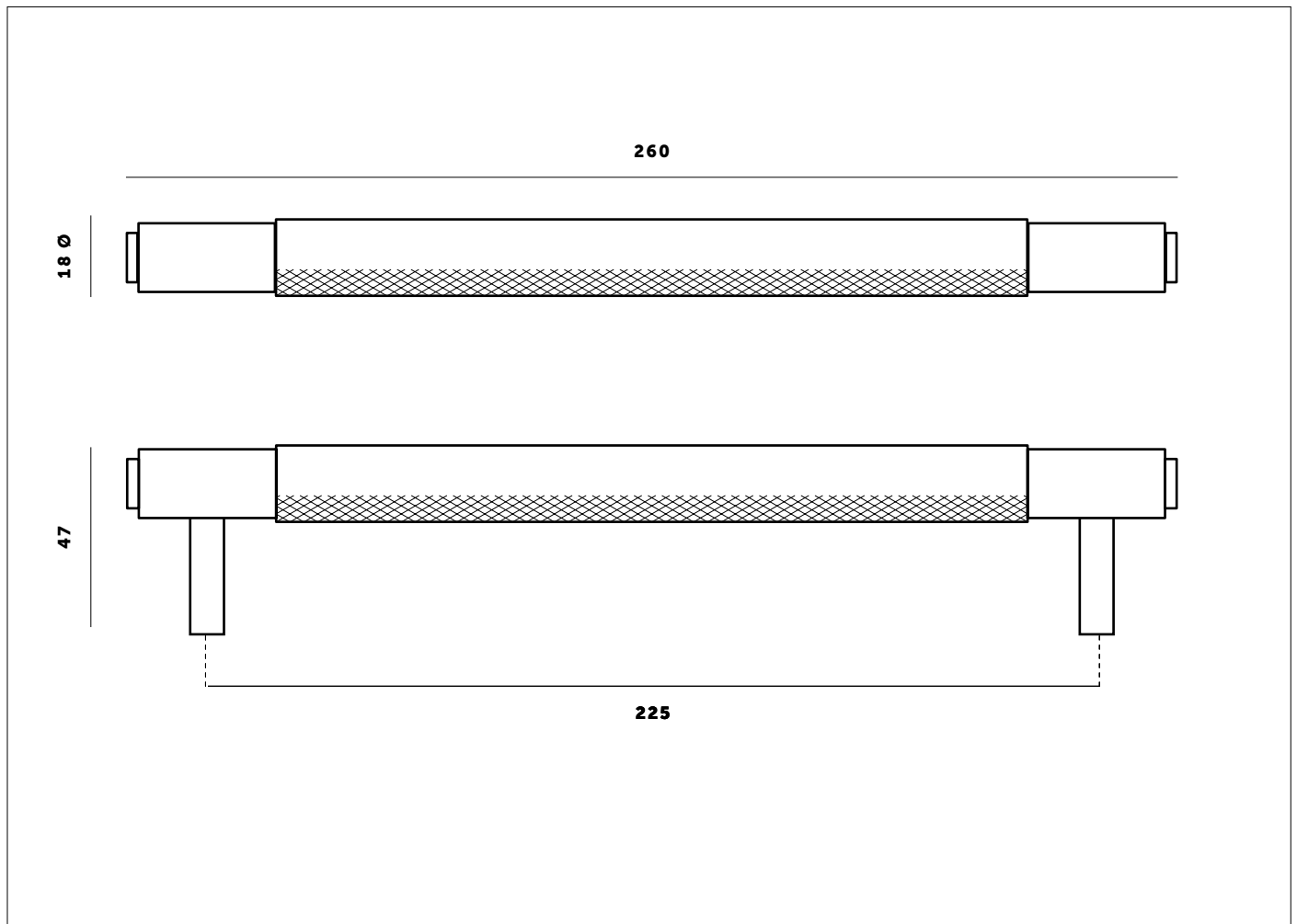

FINISH	SKU	ALSO INCLUDED:
Steel	UK-PB-H-260-ST-A	2x M5 x 30 mm screw* 2x Washer  2 pcs 2 pcs
Brass	UK-PB-H-260-BR-A	
Smoked Bronze	UK-PB-H-260-SM-A	
Black	UK-PB-H-260-BL-A	
		Handle is fitted from behind cabinet door and can not be front face fitted.

CARE INSTRUCTIONS

Wipe with damp cloth with no loose hairs, avoid using any chemicals. Please note all finishes are prone to aging.





* Fits doors & draws of max 20 mm.

BUSTER + PUNCH

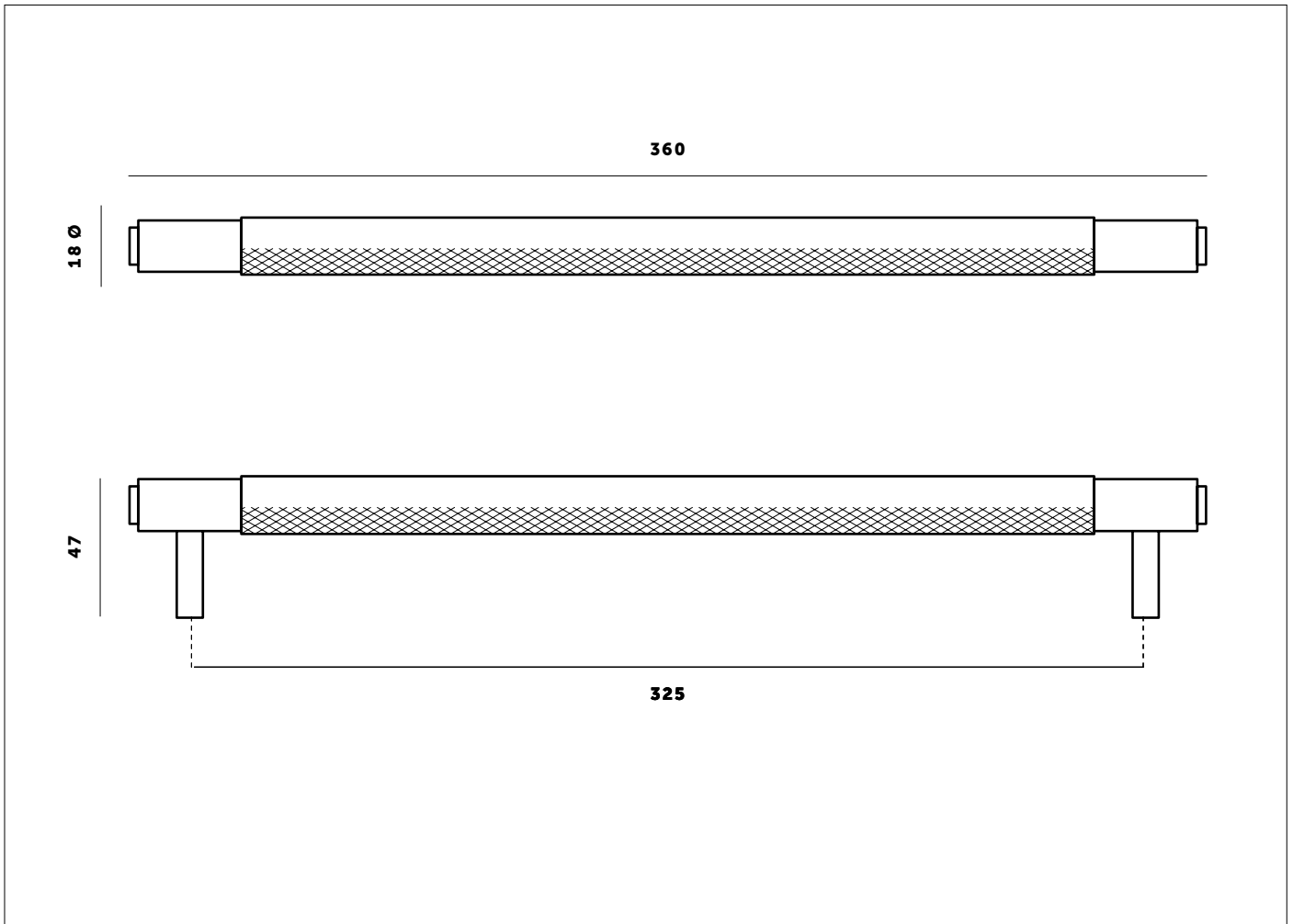
PULL BAR / LARGE

TECH SPEC



FINISH	SKU	ALSO INCLUDED:
 Steel	UK-PB-H-360-ST-A	2x M5 x 30 mm screw* 2x Washer  2 pcs 2 pcs
 Brass	UK-PB-H-360-BR-A	
 Smoked Bronze	UK-PB-H-360-SM-A	
 Black	UK-PB-H-360-BL-A	
		Handle is fitted from behind cabinet door and can not be front face fitted.

CARE INSTRUCTIONS

Wipe with damp cloth with no loose hairs, avoid using any chemicals. Please note all finishes are prone to aging.

* Fits doors & draws of max 20 mm.

PULL BAR

1. Drill holes, drill template available to download from busterandpunch.com.
2. Attach pull bar to door from the back with screws & washer.

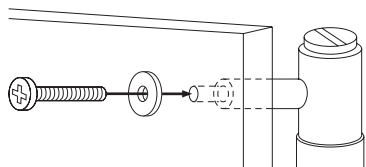

Contents

- 2x M5 x 30 mm screw*
- 2x Washer

*Fits doors & drawers of max 20 mm.

PULL BAR / PLATE

1. Drill holes, drill template available to download from busterandpunch.com.
2. Attach pull bar to door from the back with screws & washer.

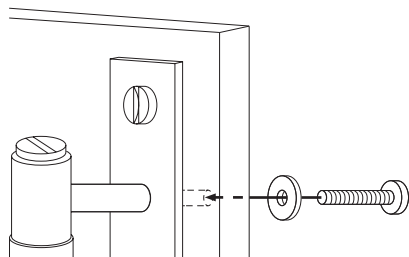

Contents

- 2x M5 x 30 mm screw*
- 2x Washer

*Fits doors & drawers of max 20 mm.



[BUSTERANDPUNCH.COM](http://busterandpunch.com)

BUSTER + PUNCH

HARDWARE

PULL BAR

EUROPE INSTRUCTIONS

CARE INSTRUCTIONS

Use mild detergent and soft damp cloth



BUSTER + PUNCH

PULL BAR

TECH SPEC

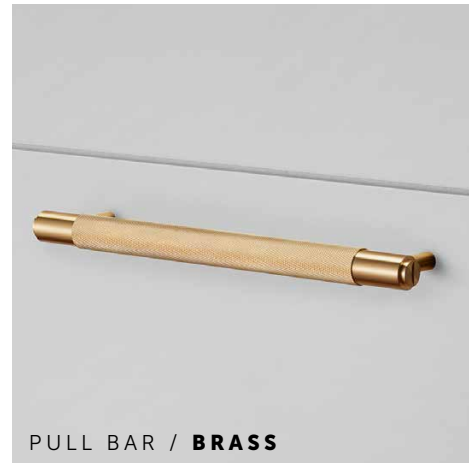

PULL BAR

A Pull Bar Handle made from solid metal. A solid bar with diamond-cut knurled handle detailing, ensuring pleasure with every touch. Works great on cabinet doors, wardrobe drawers, cupboards, kitchen units and just about anything that can open. Available in 4 metal finish combinations using brushed brass, steel, smoked bronze & satin black metal. Available complete with a rectangular plate and penny buttons or just nude.





busterandpunch.com
info@busterandpunch.com

BUSTER + PUNCH

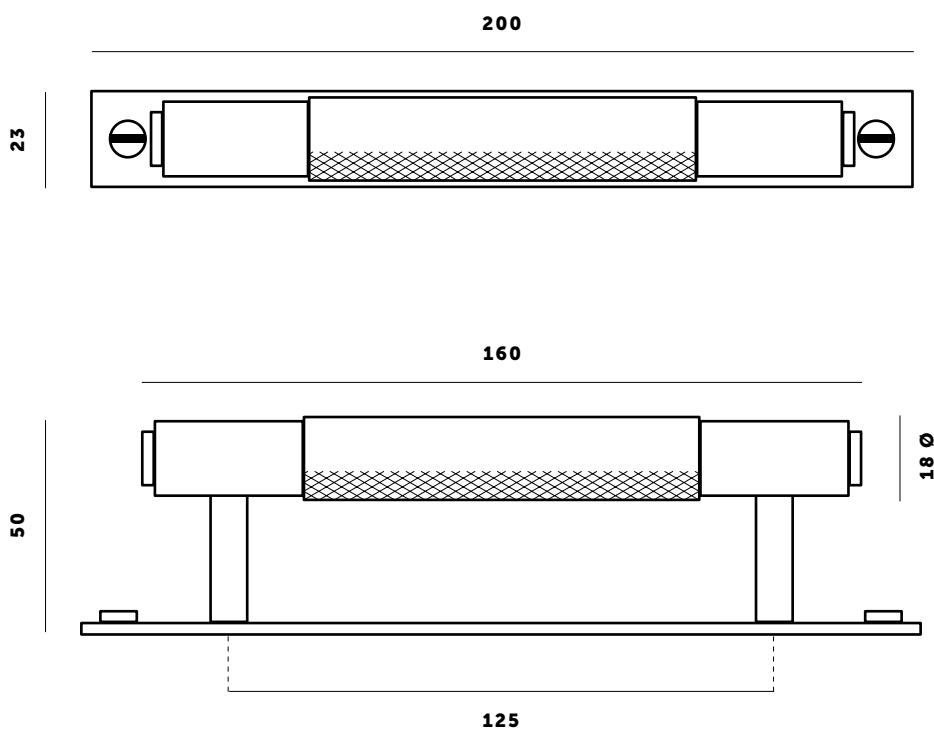
PULL BAR / PLATE / SMALL

TECH SPEC



FINISH	SKU	ALSO INCLUDED:
 Steel	UK-PB-HP-160-ST-A	2x M5 x 30 mm screw* 2x Washer  2 pcs 2 pcs Handle is fitted from behind cabinet door and can not be front face fitted.
 Brass	UK-PB-HP-160-BR-A	
 Smoked Bronze	UK-PB-HP-160-SM-A	
 Black	UK-PB-HP-160-BL-A	

CARE INSTRUCTIONS

Wipe with damp cloth with no loose hairs, avoid using any chemicals. Please note all finishes are prone to aging.





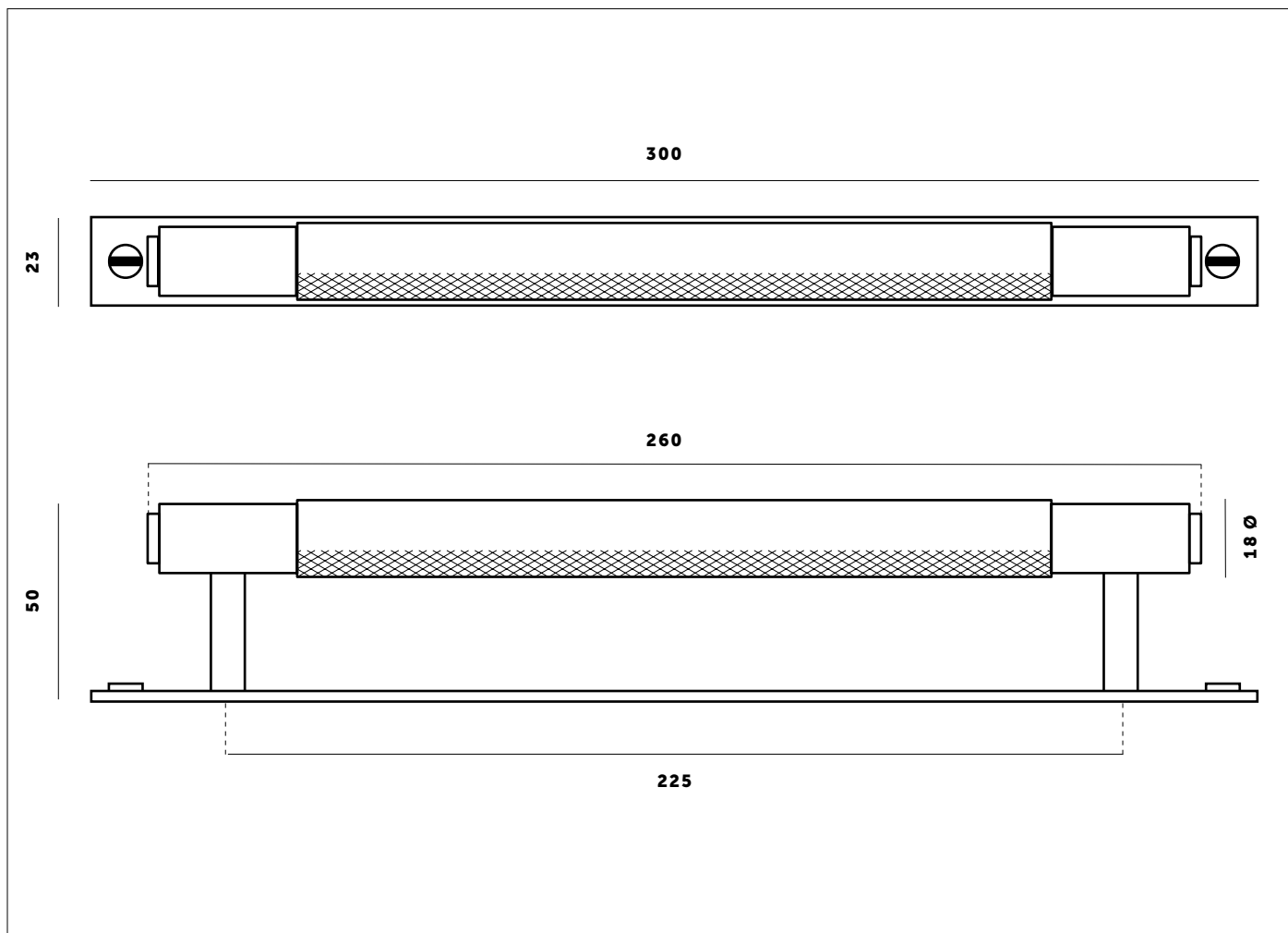

* Fits doors & draws of max 20 mm.

BUSTER + PUNCH

PULL BAR / PLATE / MEDIUM

TECH SPEC



FINISH	SKU	ALSO INCLUDED:
 Steel	UK-PB-HP-260-ST-A	2x M5 x 30 mm screw* 2x Washer  2 pcs  2 pcs
 Brass	UK-PB-HP-260-BR-A	
 Smoked Bronze	UK-PB-HP-260-SM-A	
 Black	UK-PB-HP-260-BL-A	
		Handle is fitted from behind cabinet door and can not be front face fitted.

CARE INSTRUCTIONS

Wipe with damp cloth with no loose hairs, avoid using any chemicals. Please note all finishes are prone to aging.





* Fits doors & draws of max 20 mm.

BUSTER + PUNCH

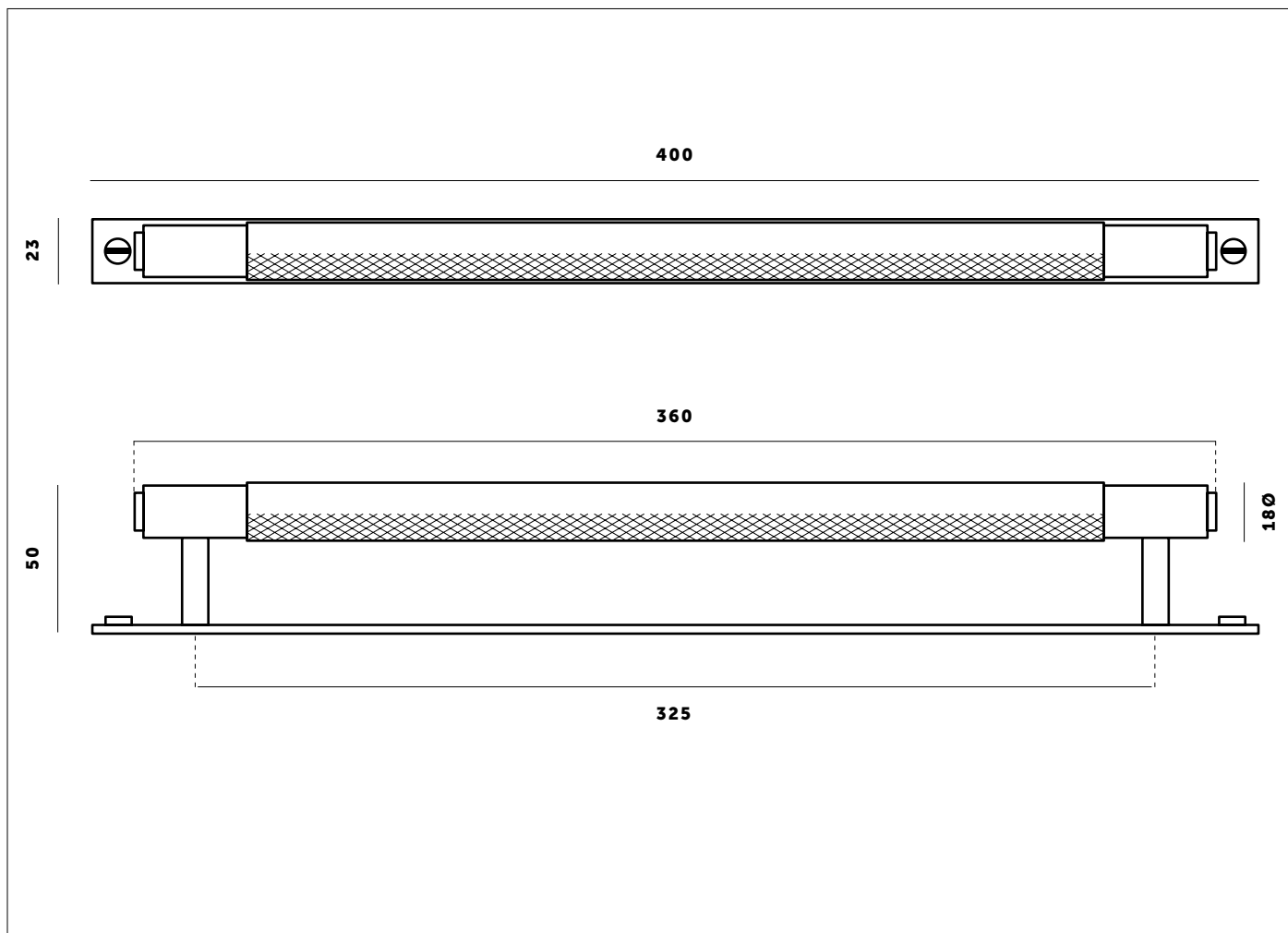
PULL BAR / PLATE / LARGE

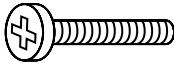
TECH SPEC



FINISH	SKU	ALSO INCLUDED:
 Steel	UK-PB-HP-360-ST-A	2x M5 x 30 mm screw* 2x Washer  2 pcs  2 pcs
 Brass	UK-PB-HP-360-BR-A	
 Smoked Bronze	UK-PB-HP-360-SM-A	
 Black	UK-PB-HP-360-BL-A	
		Handle is fitted from behind cabinet door and can not be front face fitted.

CARE INSTRUCTIONS

Wipe with damp cloth with no loose hairs, avoid using any chemicals. Please note all finishes are prone to aging.

* Fits doors & draws of max 20 mm.

PULL BAR

1. Drill holes, drill template available to download from busterandpunch.com.
2. Attach pull bar to door from the back with screws & washer.

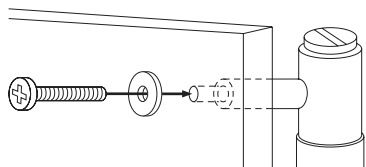

Contents

- 2x M5 x 30 mm screw*
- 2x Washer

*Fits doors & drawers of max 20 mm.

PULL BAR / PLATE

1. Drill holes, drill template available to download from busterandpunch.com.
2. Attach pull bar to door from the back with screws & washer.

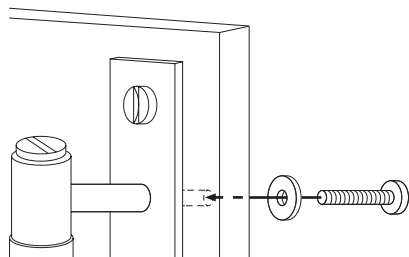

Contents

- 2x M5 x 30 mm screw*
- 2x Washer

*Fits doors & drawers of max 20 mm.



[BUSTERANDPUNCH.COM](http://busterandpunch.com)

BUSTER + PUNCH

HARDWARE

PULL BAR

EUROPE INSTRUCTIONS

CARE INSTRUCTIONS

Use mild detergent and soft damp cloth

