



MAGISTRETTI 03 01

TECHNISCHES BLATT  
SCHEDA TECNICA  
DATA SHEET  
FICHE TECHNIQUE

# MAGISTRETTI 03 01

DESIGN VICO MAGISTRETTI, 2003



Stuhl aus Buchenbugholz. Sitzschale aus Buchenschichtholz, erhältlich auch mit Lederbezug in den Farben der Kollektion.

Poltroncina in faggio curvato. Scocca in multistrato di faggio disponibile con rivestimento in cuoio nei colori di collezione.

Bent beech-wood armchair. Beech plywood shell, also available with saddle leather covering.

Petit fauteuil en hêtre cintré. Coque en hêtre contreplaqué disponible aussi avec un revêtement en cuir aux couleurs de la collection.



**SDMAGILGN**

Dimensions mm.

height 780 | width 600 | depth 600



**SDMAGITES**

Dimensions mm.

height 780 | width 600 | depth 600

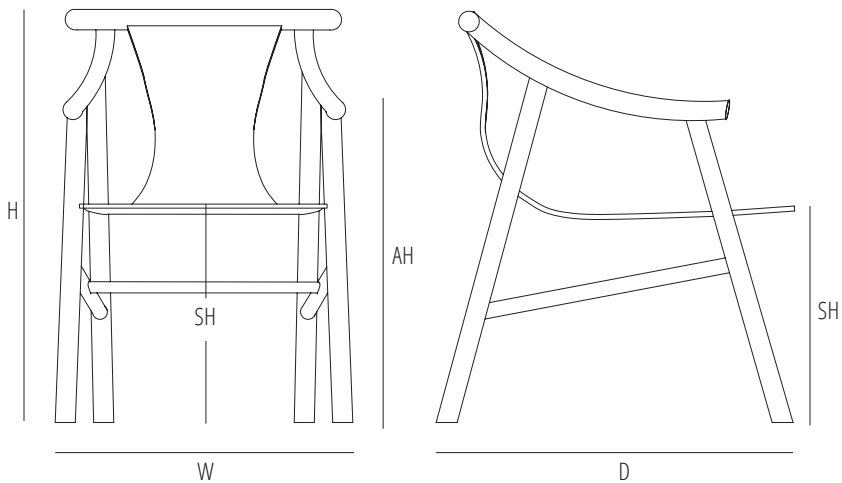

	H	W	D	SH	AH
mm	780	600	600	450	610
inch	30,7	23,6	23,6	17,7	24

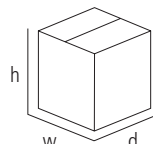
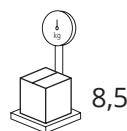
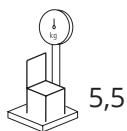
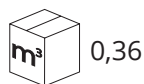
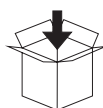
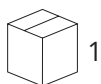

mm - inch  
h 960 - 37,7  
w 620 - 24,4  
d 600 - 23,6

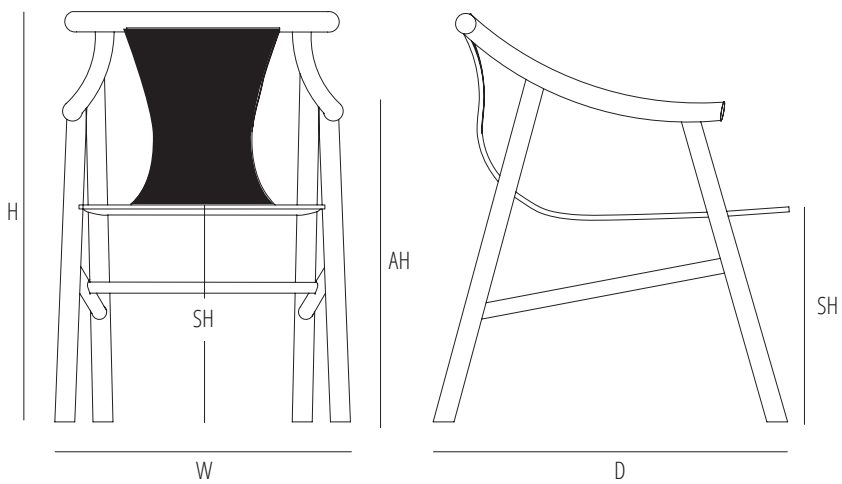

	H	W	D	SH	AH
mm	780	600	600	450	610
inch	30,7	23,6	23,6	17,7	24

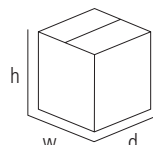
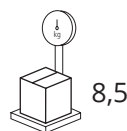
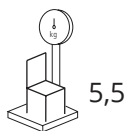
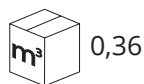
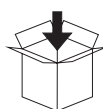
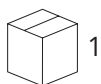

mm - inch  
h 960 - 37,7  
w 620 - 24,4  
d 600 - 23,6

Verfuegbare Ausfuehrungen  
Finiture disponibili  
Available finishes  
Finitions disponibles

SOLID WOOD / ESSENZE NATURALI



B01 BEECH  
B01 FAGGIO

STAINS / TINTI



B03 DARK WALNUT  
B03 NOCE SCURO



B04 WENGÈ  
B04 WENGÈ



B05 BEECH GLOSS O  
B05 FAGGIO GLOSS O

CLASSIC LACQUER / LACCATO CLASSICO



C01 - RAL 9005 BLACK

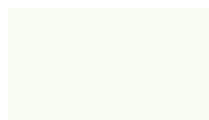

C02 - RAL 9010 PURE WHITE

CONTEMPORARY LACQUER / LACCATO CONTEMPORANEO



D01 - RAL 1013 PEARL WHITE



D02 - RAL 7047 TELEGREY 4



D03 - RAL 7030 STONE GREY



D19 - S7502 G DARK GREY



D21 - S1510 Y80R POWDER PINK



D20 - S2570 Y60R ORANGE



D10 - RAL 3000 FLAME RED



D14 - RAL 3005 WINE RED



D22 - S1515 R90B LIGHT BLUE



D11 - RAL 7000 SQUIRREL GREY



D12 - RAL 7031 BLUE GREY



D25 - RAL 5011 STEEL BLUE



D15 - RAL 5020 OCEAN BLUE



D24 - S2070 Y10R YELLOW OCRE



D07 - RAL 1027 CURRYYELLOW



D23 - S6020 G10Y DARK GREEN

Gebrüder Thonet Vienna GmbH  
Prinz Eugen Straße 42  
1040 Wien (AT)

**[www.gebruederthonetvienna.com](http://www.gebruederthonetvienna.com)**

Offices of the trademarks' licensee  
Production Furniture International S.p.A.  
Via Foggia, 23/H  
10152 Torino (TO) Italy

Phone: 0039 011 0133330 - [info@gebruederthonetvienna.com](mailto:info@gebruederthonetvienna.com)