

FRITZ HANSEN



SELANDIA
PRODUCT FACT SHEET

SELANDIA

The Selandia series is known for its signature slight curves and elegant Nordic look with subtle French references that hint at long summer nights in the open air. The series is the essence of practicality meets beauty as it offers both foldable chairs and tables as well as other elegant and functional details.

PRODUCT TYPE

Chair/Armchair
Bench
Table

ENVIRONMENT

Outdoor

DESIGNER

Anders & Lars Hegelund
Mogens Holmriis

MODELS

Chair
Armchair
2-seater
Table (Ø94)
Table (75)
Table (147)
Table

MATERIAL

Teak (Untreated)
Brass (Untreated)

FEATURES

- Chair/Armchair/2-seater is foldable
- Table (Ø94) is foldable into a half-circle table
- All tables are foldable for easy storage
- Table (S1450520) is extendable (two extension plates can be added, not included in the table) and it has an umbrella opening
- Cushions (Please find further details on p. 6-8)

MADE-TO-ORDER

N/A

CERTIFICATION

- FSC™ FSC-C120451: The wood used for Selandia is FSC-certified (FSC 100%). The FSC-certification ensures the wood is from responsible and environmentally managed forests that preserve the natural surroundings and support the local community.

For more information about environment and manufacturing processes, please download our environmental information sheet at: fritzhanzen.com

TEST

Chair/Armchair: EN 581-1:2017, EN 581-2:2015
Table 147/Table Ø94: EN 581-1:2017, EN 581-3:2017
Table 75: EN 581-1:2017

SPECIFICATIONS

Wood: New wooden, teak furniture has natural colour differences found in the freshly cut wood. Once the furniture has been exposed to the sun, these colour differences will even out. As a natural part of the aging process, the surface of teak will change when first being exposed to rain; this is the first stage of a process of wood that ages with beauty.

WEIGHT

| | |
|--------------|-------------------|
| Chair: | 4 kg / 8.8 lb |
| Armchair: | 5,9 kg / 12.9 lb |
| 2-seater: | 14 kg / 30.9 lb |
| Table (75): | 9,6 kg / 21.2 lb |
| Table (147): | 24 kg / 52.9 lb |
| Table (Ø94): | 19,6 kg / 43.1 lb |
| Table: | 38,1 kg / 36.2 lb |

COUNTRY OF ORIGIN

Wood origin: Indonesia, Brazil, Panama, Costa Rica

PRE-ASSEMBLED

Chair units: Yes
Table units: No

PACKAGING

The units are shipped in a recycled cardboard box. All packaging material can be recycled.

CLEANING AND CARE

Find recommendations for cleaning and care at: fritzhanzen.com/maintenance

REPAIR, DISPOSAL AND REUSE

In case of repair and disposal the units can be disassembled into parts. All parts can be recycled. Check local regulations for recycling options and whether there is potential for reuse.

WARRANTY

Fritz Hansen provides a five-year warranty on standard products against defects in materials and workmanship.

Additional warranty conditions can be found at: fritzhanzen.com/warranty

DIMENSIONS

CHAIR

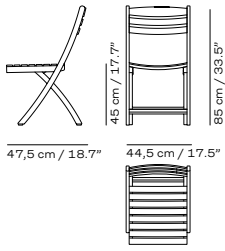

ARMCHAIR

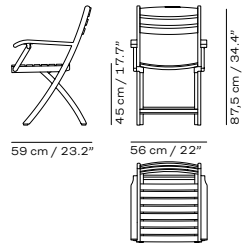

2-SEATER

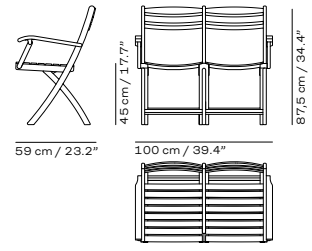

TABLE (Ø94)

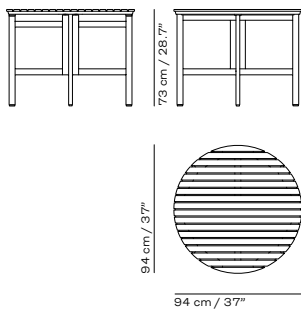

TABLE (75)

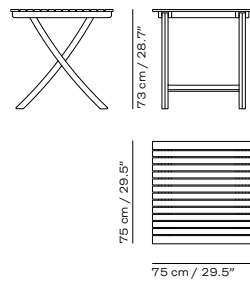
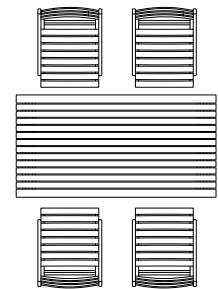
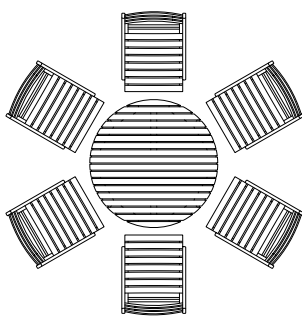
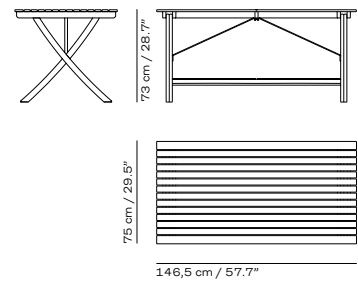
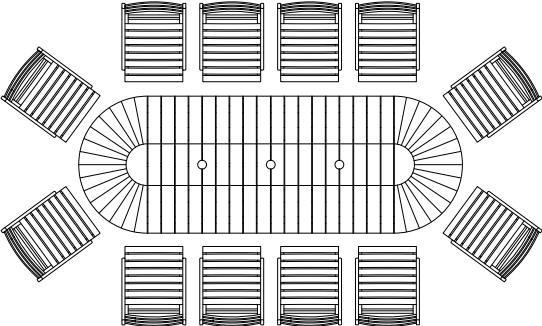
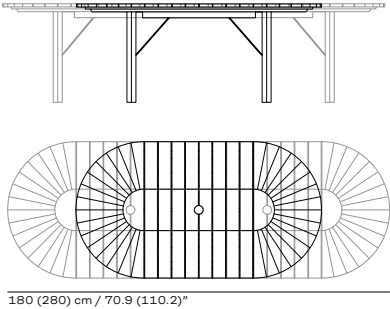
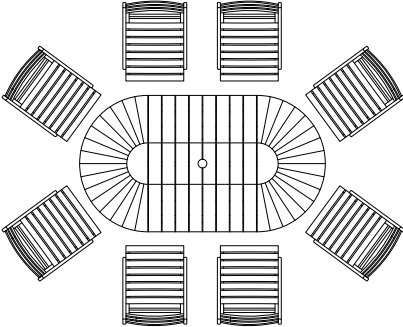
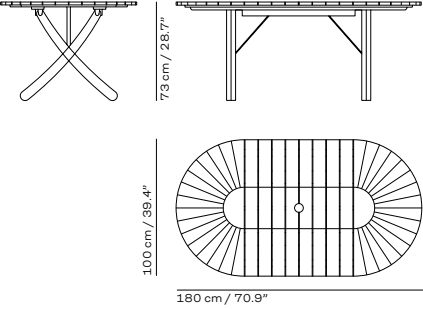

TABLE (147)



DIMENSIONS

TABLE



EXTENSION PLATE



VARIANTS

CHAIR



TEAK
S1400503

ARMCHAIR



TEAK
S1400505

2-SEATER



TEAK
1400516

TABLE (147)



TEAK
1400517

TABLE (75)

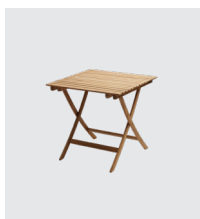

TEAK
1400518

TABLE (Ø94)



TEAK
1400519

TABLE



TEAK
S1450520

EXTENSION PLATE

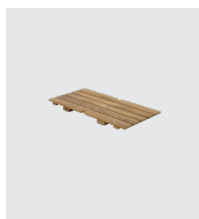

TEAK
1450525

CUSHIONS

DESCRIPTION

Selandia cushions are custommade to fit the Selandia collection with strings to keep the weatherproof cushion in place. Exceptionally quick drying thanks to an open-cell structure foam that allows water and air to pass through, the cushion retains a firm and comfortable feel year after year. The upholstery is Oeko-Tex® certified and extremely colourfast as well as water and dirt-repellent and mildew-resistant.

ENVIRONMENT

Outdoor

DESIGNER

Skagerak Design

MODELS

Armchair Cushion
Chair Cushion

MATERIAL

Outdoor textile
Quickdry outdoor foam

The cushion range for the UK/IE is different from the main collection in order to meet local fire regulations*.

UPHOLSTERY

The following selection of textiles* is available:

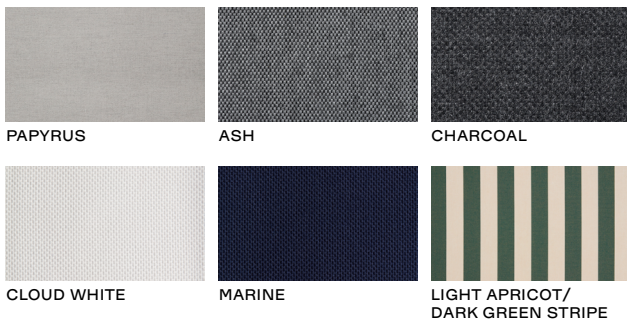

MADE-TO-ORDER

N/A

CERTIFICATION

Textiles: Oeko-Tex®.

For more information about environment and manufacturing processes, please download our environmental information sheet at: fritzhanzen.com

TEST

N/A

*For details specific to UK/IE go to p. 8.



SPECIFICATIONS*

The quickdry outdoor foam provides a firm and comfortable seat that retains its shape year after year. The open-cell structure allows both water and air to pass through ensuring the cushion dries exceptionally quickly, even after a heavy downpour. To ensure cushions remain beautiful over time, it is good practice to avoid them being left wet for prolonged periods, e.g., by turning them upright to let water run off or storing them in a dry environment.

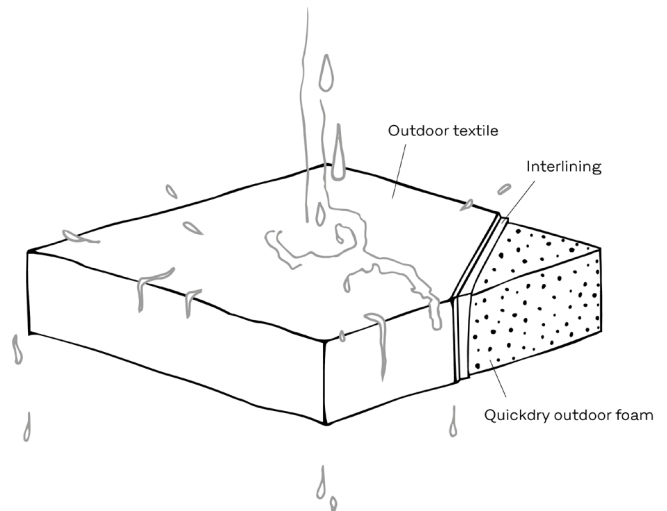

WEIGHT

Armchair Cushion: 0,4 kg / 0.8 lb
Chair Cushion: 0,3 kg / 0.6 lb

COUNTRY OF ORIGIN

Produced in: Poland

PRE-ASSEMBLED

Yes

PACKAGING

The units are wrapped in a plastic bag.
All packaging material can be recycled.

CLEANING AND CARE

Find recommendations for cleaning and care at:
fritzhanzen.com/maintenance

REPAIR, DISPOSAL AND REUSE

In case of repair and disposal the units can be disassembled into parts. All parts can be recycled. Check local regulations for recycling options and whether there is potential for reuse.

WARRANTY

Fritz Hansen provides a five-year warranty on standard products against defects in materials and workmanship.

Additional warranty conditions can be found at:
fritzhanzen.com/warranty

DIMENSIONS

ARMCHAIR CUSHION

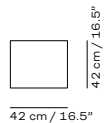

CHAIR CUSHION

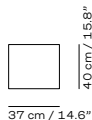

VARIANTS*

CHAIR CUSHION



MARINE
1961044



ASH
1961045

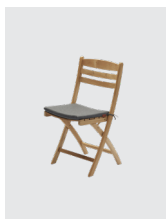

CHARCOAL
1961046

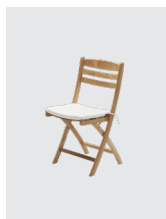

CLOUD WHITE
1961047



PAPYRUS
1961143



LIGHT APRICOT/
DARK GREEN STRIPE
1961145

ARMCHAIR CUSHION



MARINE
1961040



ASH
1961041



CHARCOAL
1961042



CLOUD WHITE
1961043



PAPYRUS
1961142



LIGHT APRICOT/
DARK GREEN STRIPE
1961144

*For details specific to UK/IE go to p. 8.

VARIANTS (UK/IE)

CHAIR CUSHION



ASH
1961082



CHARCOAL
1961083



PAPYRUS
1961206



LIGHT APRICOT/
DARK GREEN STRIPE
1961225

ARMCHAIR CUSHION



ASH
1961080



CHARCOAL
1961081



PAPYRUS
1961205



LIGHT APRICOT/
DARK GREEN STRIPE
1961224

IMPORTANT NOTE!

Under current UK law, Fritz Hansen is not able to provide outdoor cushions and pillows with the same filling as the regular collection. We still offer cushions and pillows in an outdoor textile with weatherproof properties, but the filling is not weatherproof due to stringent (indoor) fire regulations. We therefore recommend that you bring cushions and pillows indoors in heavy rain and when they are not in use.

The FR cold foam provides a firm and comfortable seat that retains its shape year after year. The FR cold foam is not weather resistant, and therefore it is recommended to store the cushions indoor when not in use and during heavy downpour. To ensure cushions remain beautiful over time, it is good practice to avoid them being left wet for prolonged periods, e.g., by turning them upright to let water run off or storing them in a dry environment.