



Lotus is a complete collection of seats composed of low, medium and high armchairs, fits easily into a home décor or in a variety of work situations thanks to the many ways its seat can be customized with different covers and sizes.

Used materials

Structure:

1. Beech plywood

Padding:

2. Multi-density polyurethane foam; polyurethane foam cushions hot-pressed with cover, elastic belts. Cover fixed in fabric, leather G, leather Extra G2.

Armrest:

3. Chromed aluminium, padded with co-injection polyurethane rigid and flexible foam.

Base:

4. Four or five spokes, in die-cast aluminium, swivel, tilting and with adjustable height

Base and armrest finishing:

Polish chrome or matt lacquer dark brown, mud, white

Casters:

5. Chromed carter, grey plastic caster suitable for semisoft surfaces. Carter matt lacquer in dark brown, mud or white

Feet:

6. White plastic for chromed base and matt lacquer white.

Black plastic for matt lacquered base brown and mud

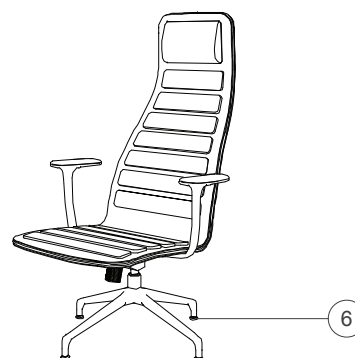
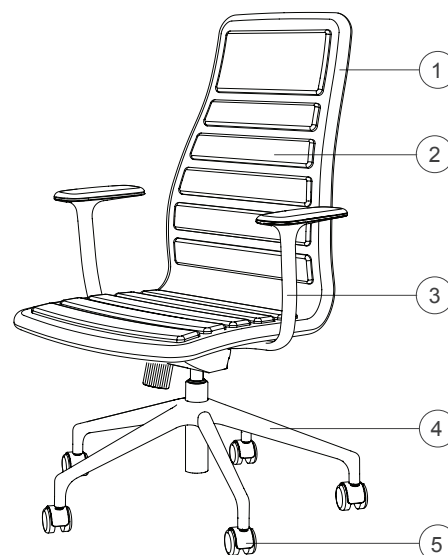

Dimensioni

LS_3

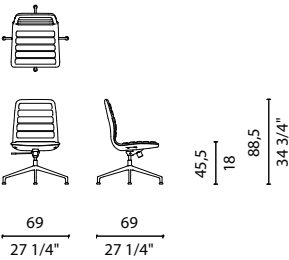

LS_3CB

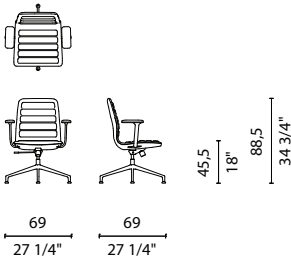

LS_35

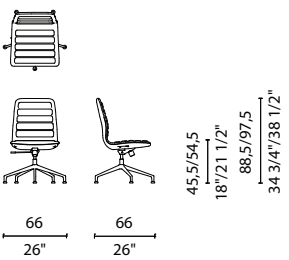

LS_35CB

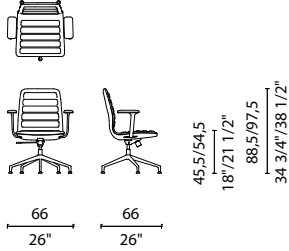

LS_35CR

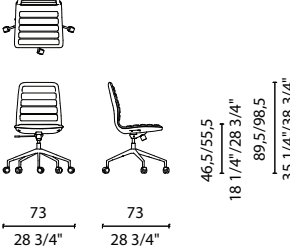

LS_35CBR

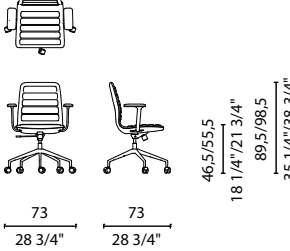

LS_4

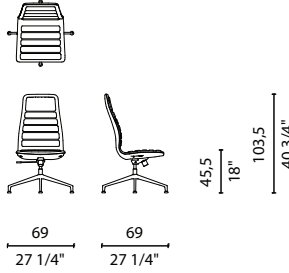

LS_4CB

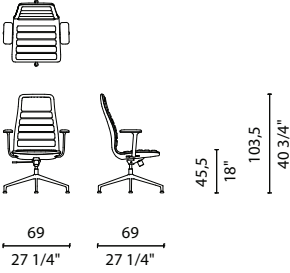

LS_45

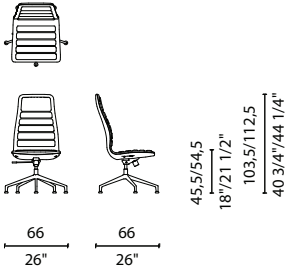

LS_45CB

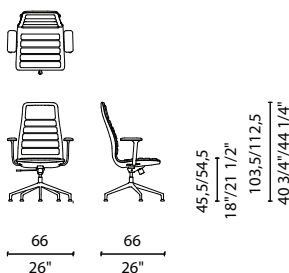

LS_45CR

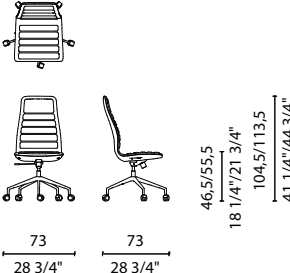

LS_45CBR

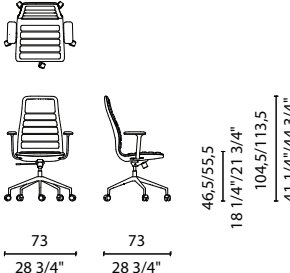

LS_5

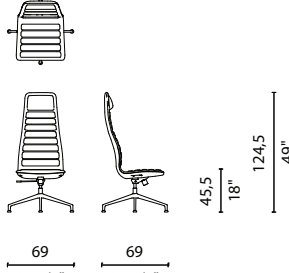

LS_5CB

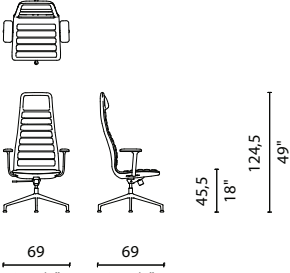

LS_55

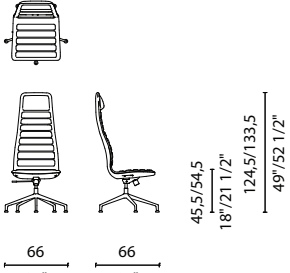

LS_55CB

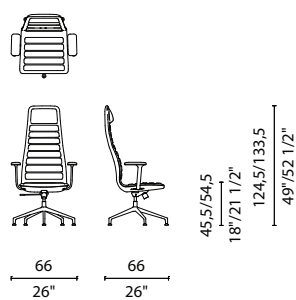

LS_55CR

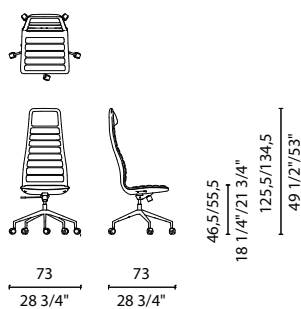

LS_55CBR

