

THORUP

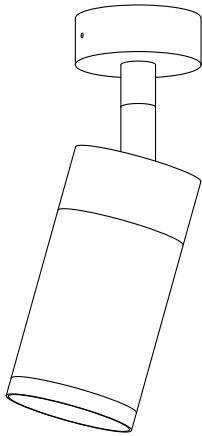

PATRONE LIGHTING USER GUIDE

CRAFTED IN COPENHAGEN

Enjoy your new Patrone Lighting! Please ensure a smooth installation process and make the most of your product by following these instructions carefully.

Please note that each lamp is meticulously crafted in Copenhagen, resulting in a unique product with potential variations

It's important to install and use your Patrone Lighting correctly and only for its intended purpose. We recommend consulting a qualified electrician for installation.

Thorup cph cannot be held liable for any damages resulting from improper installation or modification of the lamp.

Technical Specifications:

LED GU10, max 4 Watts

Compatible with bulbs of energy classes A++

Designed for indoor use only

For any inquiries or assistance, please don't hesitate to contact us at info@thorupcph.com

CONTENT

- Ceiling lamp fitted with canopy & wall bracket
- 2 x screws (for mounting the lamp with the wall bracket)
- 1 x Hex / Allen key (to tighten the pinol canopy)
- White gloves (Wear when installing the brass and nickel-plated brass version, to avoid dark marks on the product).

SPARE PART NEEDED

- Bulb Type: LED GU10

INSTRUCTIONS

- Please read the instructions carefully before commencing assembly.
- Installation should be carried out in accordance with local safety regulations.
- Do not change the lightbulb while the fixture is switched on.
- The lamp is intended for indoor interior use only.
- In order to prevent damage, please check walls for cables before drilling holes.

MOUNTING

Mounted directly to finished surface with the circular canopy. Standard configured as hard-wired to be installed directly, but can be re-configured to plug-in.

MATERIALS

Brass is a natural material that develops a unique patina over time, enhancing its character. Exposure to air and humidity will cause brass to oxidize and discolor, which adds to its distinctive charm.

Due to the handcrafted process, each lamp may have slight variations, adding to its uniqueness.

CARE GUIDE

This product is made from solid brass. For routine cleaning, gently wipe with a soft, dry cloth. Avoid using sponges, polishing creams, or abrasive cleaners. To maintain the brightness and remove spots and stains from the solid brass version, we recommend using our Brass Care Kit.

For additional details on product care and spare parts, please visit thorupcopenhagen.com/care-guide



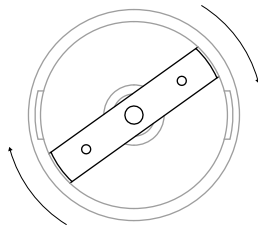

Step 1

To unfasten the wall-bracket from the canopy carefully turn it clockwise until it is released.

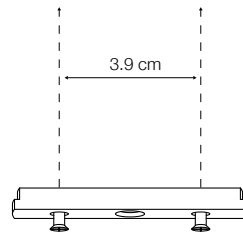

Step 2

Drill the holes with a distance of 39 mm. for the bracket, and use the correct type of screw and plug for the type of wall. Tighten the screws and ensure the bracket is safely fixed in place.

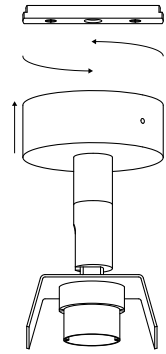

Step 3

Place the canopy over the wall-bracket. Align the canopy on the bracket by carefully turning it anti-clockwise until it is fixed in place.

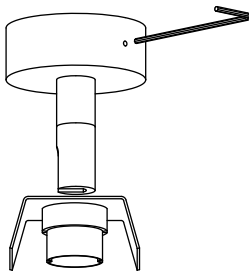

Step 4

Carefully tighten the pinol with the included Hex / Allen key. Ensure not to over-tighten the pinol as it may cause damage to the product.

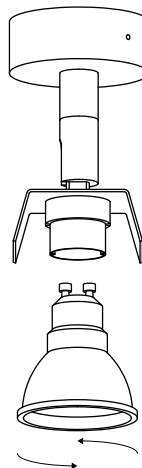

Step 5

Install the LED bulb firmly by pushing it upwards and carefully turn clockwise until it is fixed in place.

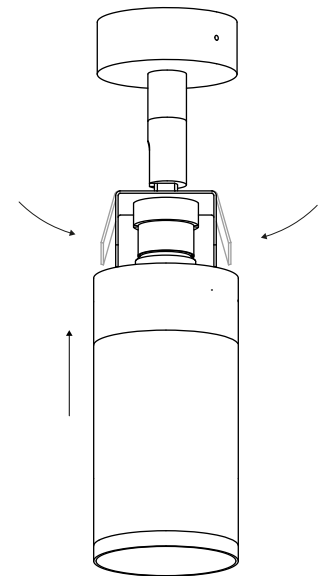

Step 6

Install the shade, by gently pressing the two sides inwards to enclose the insert with the fixture.

Adjustment options

Utilize the tiltable and rotatable neck to adjust the shade to your desired angle.

Rotation angle: 0-350°
Tilt angle: 0-65°

