

# Eames Tables

Charles & Ray Eames, 1964/1968



## Eames Tables

The design story of the Eames Tables harks back to the 1940s, when Charles and Ray Eames developed the first versions of what later became the table base. These early designs, which already reflect the designer couple's characteristic method of thinking in systems, were suited for a variety of chairs and tables. The bases used today for the Eames Tables were created in the 1960s in conjunction with the development of the Soft Pad Chairs.

The Eames Tables are distinguished by their rational construction and aesthetic understatement. For decades they have facilitated communication, teamwork and interaction in offices, public spaces and homes. They meet today's requirements with intelligent power and data solutions and modern technologies such as wireless charging.

This table family comprises the large-surface Segmented Tables, the smaller Contract Tables and the low Side Tables. High-quality materials guarantee an unusually long product lifespan. All models are available with HPL tops, which have a distinctive rounded black plastic edge, or in a choice of wood veneers. The Eames Contract Tables and Side Tables are also offered with melamine-faced or solid core tops, the latter of which are suited for outdoor use.



## Charles & Ray Eames

Charles and Ray Eames are counted among the most important figures of twentieth-century design. Their work spans the fields of furniture design, filmmaking, photography and exhibition design. Vitra is the sole authorised manufacturer of Eames products for

Europe and the Middle East. When you own an Eames product made by Vitra, you know it is an original.

1	Eames Tables
2-5	Configurations
6-7	Table shapes
8-9	Electrification

10-11	Bases
12-13	Dimensions
13	Colours and materials
14-15	Eames Side Tables

16-17	Eames Contract Tables
18-20	Eames Segmented Tables Meeting



**Eames Side Table, round**, Ø700 mm, height 550 mm, table top in light oak veneer, legs and column chrome-plated; sofa: Mariposa Club

---



**Eames Side Table, square**, 750x750 mm, height 400 mm, table top in dark oak veneer, legs and column powder-coated in deep black; chairs: EA 216

---



**Eames Side Tables, round**, Ø800 mm, height 400 mm and 550 mm, white HPL table top with black edge, legs with polished finish, column in basic dark; chairs: EA 116 and EA 124

---



**Eames Contract Table, square, 750x750 mm, white melamine table top, legs and column powder-coated in white; chairs: .03**

---



**Eames Contract Table, round, Ø800 mm, white HPL table top with black edge, legs and column powder-coated in deep black; chairs: EFC**

---



**Eames Contract Table, square, 750x750 mm, solid core table top with black edge, legs and column powder-coated in white and black, outdoor version; chair: Wire Chair**

---



**Eames Segmented Table Meeting, round, Ø1300 mm, 4 places, white HPL table top with black edge, legs with polished finish, column in basic dark, electrification: Punto Wireless Charging; chairs: .03**



**Eames Segmented Table Meeting, boat-shaped, 2000x1150 mm, 6 places, white HPL table top with black edge, legs and column chrome plated; chairs: EFC**



**Eames Segmented Table Meeting, round, Ø2000 mm, 6-8 places, table top in light oak veneer, legs with polished finish, column in basic dark, electrification: Punto Power/USB; chairs: EA 108**





**Eames Segmented Table Meeting, boat-shaped, 3600x1300 mm, 10 places, table top in dark oak veneer, legs and column chrome-plated, electrification: Rotax; chairs: Softshell Chair**



**Eames Segmented Table Meeting, boat-shaped, 8000x2000 mm, 20+ places, table top in American walnut veneer, legs and column in deep black, electrification: Aletta; chairs: EA 208**



Eames Side Tables



-  Ø 700 mm
-  Ø 800 mm
-  750 x 750 mm



Eames Contract Tables



-  Ø 700 mm  
seats 2
-  Ø 800 mm  
seats 3-4
-  750 x 750 mm  
seats 4

Eames Segmented Tables Meeting

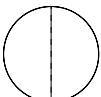

-  Ø 1100 mm  
seats 4
-  Ø 1300 mm  
seats 4-6
-  Ø 2000 mm  
seats 6-8

Eames Segmented Tables Meeting

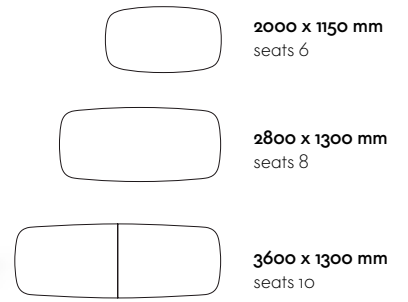
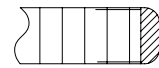

TABLE TOPS



White HPL (25 mm) with black edge



White melamine-faced (25 mm) with smooth, straight plastic edge in white

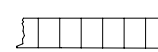

White solid core (12 mm) with black edge

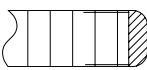

Light oak veneer (25 mm) with straight veneered edge



American walnut veneer (25 mm) with straight veneered edge



Dark oak veneer (25 mm) with straight veneered edge

	White HPL with black edge	White melamine with white plastic edge	White solid core with black edge*	Veneer, light oak	Veneer, American walnut	Veneer, dark oak
Side Tables	●	●	●	●		●
Contract Tables	●	●	●	●		●
Segmented Tables Meeting	●			●	●	●

\*suited for outdoor use

**New integrated electrification**

The base for Eames Segmented Tables has undergone complex revision to allow the elegant integration of modern power and data connections. The cables are fed discreetly

through the column so as not to affect the modularity of the sophisticated base, and the tables' visual appearance remains unaltered.



**Electrification example\***

- 1 Punto Wireless Charger
- 2 Set of electrification cables



Punto Power



Punto USB



Punto Wireless Charging

Only the spider has been unobtrusively expanded to incorporate the new Punto power module. Aletta or Rotax flaps can be selected for the table top and equipped with the new Punto solu-

tion, which comes with power, USB or wireless charging options.



**Electrification example\***

- 1 Punto Power
- 2 Rotax
- 3 Aletta
- 4 Punto USB
- 5 Set of electrification cables

For further information regarding electrification or customer-specific solutions, please contact your Vitra sales representative.

\* Please observe local electrical regulations!



Rotax



Aletta



## BASES FOR CONTRACT TABLES, SIDE TABLES

**vitra.**



polished / basic dark



chrome-plated / basic dark



all chrome



powder-coated in deep black



powder-coated in white

## BASES FOR SEGMENTED TABLES MEETING



### Segmented base

consisting of legs, columns, spreaders and spiders for rectangular or boat-shaped table tops



chrome / basic dark



polished / basic dark



chrome / chrome



deep black

\*suited for outdoor use

## **BASES FOR SEGMENTED TABLES MEETING CUSTOMISED TABLE SYSTEMS**

The base construction of Eames Segmented Tables follows an ingenious concept that allows the modular combination of different components. The segmented base consists of legs, spreaders, columns and table top supports. The legs and spreader can be connected to the column at different angles,

creating modules suited to table tops of diverse shape and size. Tables of up to 10 m in length and 1.7 m in width can be created using the VCS Configurator.



### **Segmented base**

consisting of legs, columns, spreaders and spiders for large, customised table systems

---

**DIMENSIONS**

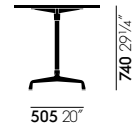

Ø700 Ø27 1/2"  
Ø800 Ø31 1/2"



750 29 1/2"



Ø700 Ø27 1/2"  
Ø800 Ø31 1/2"



750 29 1/2"

Eames Side Table,  
ø 700, ø 800

Eames Side Table,  
750 x 750

Eames Contract Table, ø  
700, ø 800, ø 900

Eames Contract Table,  
750 x 750

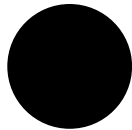
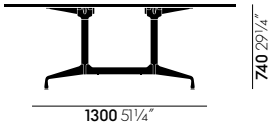

Ø1100 43 1/4"  
Ø1300 51 1/4"

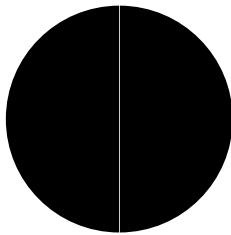

Ø2000 Ø78 3/4"

Eames Segmented Table,  
ø 1100, ø 1300

Eames Segmented Table Meeting,  
ø 2000

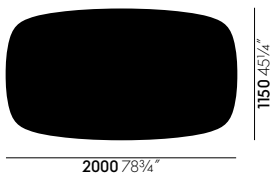
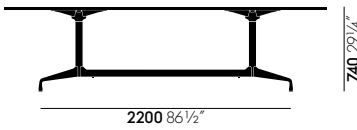
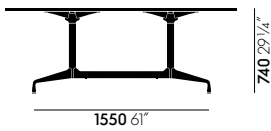

2000 78 3/4"

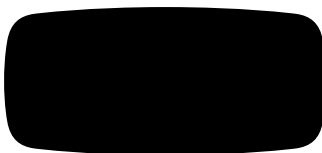

2800 110 1/4"

Eames Segmented Table Meeting,  
2000 x 1150

Eames Segmented Table Meeting,  
2800 x 1300

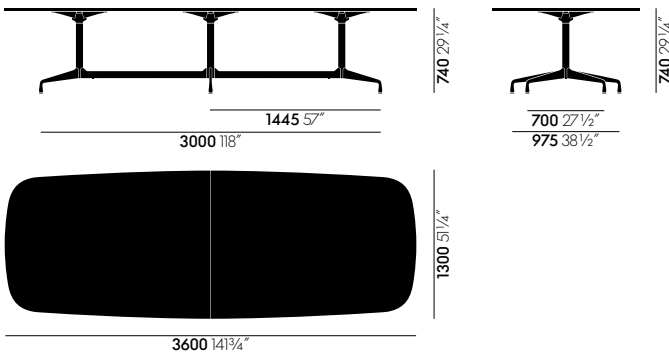

Eames Segmented Table Meeting,  
3600 x 1300

COLOURS AND MATERIALS

Eames Contract und Side Tables

	<b>04</b> white powder-coated (textured)		<b>01</b> white (textured)
	<b>01</b> chrome		<b>12</b> white (smooth)
	<b>03</b> aluminium polished		<b>17</b> light oak
	<b>12</b> deep black powder-coated (textured)		<b>03</b> white (textured)
	<b>30</b> basic dark powder-coated (smooth)		<b>04</b> dark oak, protec- tive varnish

**Base** **Table top (Contract & Side Tables)**

Eames Segmented Tables Meeting

	<b>01</b> chrome		<b>04</b> dark oak, protec- tive varnish
	<b>03</b> aluminium polished		<b>13</b> American walnut
	<b>30</b> basic dark powder-coated (smooth)		<b>12</b> white (smooth)
	<b>12</b> deep black powder-coated (textured)		<b>17</b> light oak

**Base** **Table top (Eames Segmented Tables)**



The Vitra Configuration System (VCS) software contains comprehensive information on all Vitra products and assists you in the preparation of plans and offers. VCS is available through your sales representative or at [vcs@vitra.com](mailto:vcs@vitra.com).

Planning data, further information and illustrations can be found on the Vitra extranet for architects: [www.vitra.com/extranet](http://www.vitra.com/extranet). To verify your colour selections, please order the Vitra Colour and Material Sample Box.



# Eames Side Tables

Charles & Ray Eames, 1968

**vitra.**



**Eames Side Tables**

For the Eames Side Tables, Charles and Ray Eames developed lower versions of the same base they had designed for the Contract Tables. Owing to their affinity with the Aluminium and Soft Pad Chairs, the Side Tables are perfectly suited for lounge and waiting areas equipped with these Vitra chairs, but also cut a fine figure alongside any armchair or sofa.

The Eames Side Tables come with a round top in a choice of two sizes or as a square model. Both versions are available in two different heights.

## **Materials**

- **Table tops:** available in four materials: melamine-faced white surface (25 mm) with smooth, flat plastic edge in white; light or dark oak veneer (Europe) (25 mm) with flat veneer edge; solid core material in white (12 mm) with black edge; HPL (25 mm) with black edge.
- **Base:** stable pedestal base, four-star legs in die-cast aluminium. Available in four versions: base polished or chrome-plated with column in basic dark (RAL 9004), all chrome or all powder-coated (textured finish) in deep black (RAL 9005) or white (RAL 9010). The height of the base including screw-in glides is 52 mm and 37 mm; the glides can be adjusted (max. extension 10 mm) for levelling on uneven floors.
- **Applications:** the powder-coated base can be paired with a solid core table top for outdoor use.

**DIMENSIONS**



**Eames Side Table,**  
ø 700, ø 800

**Eames Side Table,**  
750 x 750

**COLOURS AND MATERIALS**

**Eames Side Tables**

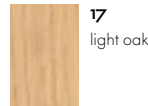
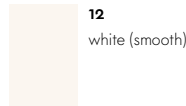
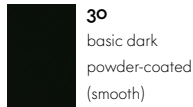
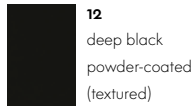
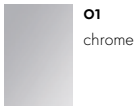
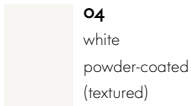

**Base**

**Table top (Contract & Side Tables)**



The Vitra Configuration System (VCS) software contains comprehensive information on all Vitra products and assists you in the preparation of plans and offers. VCS is available through your sales representative or at [vcs@vitra.com](mailto:vcs@vitra.com).

Planning data, further information and illustrations can be found on the Vitra extranet for architects: [www.vitra.com/extranet](http://www.vitra.com/extranet). To verify your colour selections, please order the Vitra Colour and Material Sample Box.



# Eames Contract Tables

vitra.

Charles & Ray Eames, 1968



Eames Contract Tables

For the Contract Tables, Charles and Ray Eames developed a universal base, whose form strongly resembles the bases of the Soft Pad Group, while the structure evokes associations with the larger Eames Segmented Tables.

The Contract Tables make perfect small meeting tables and are also ideal as bistro tables for both indoor and outdoor use. They come with a round top in a choice of two sizes or as a square model.

## Materials

- **Table tops:** available in four materials: melamine faced white surface (25 mm) with smooth straight plastic edge in white; light or dark oak veneer (Europe) (25 mm) with straight veneer edge; solid core laminate in white (12 mm) with black edge; HPL (25 mm) with black edge.
- **Base:** stable pedestal base, four-star legs in die-cast aluminium. Available in four versions: base polished or chrome-plated with column in basic dark (RAL 9004), all chrome or all powder-coated (textured finish) in deep

black (RAL 9005) or white (RAL 9010). The height of the base including screw-in glides is 71 cm; the glides can be adjusted (max. extension 10 mm) for levelling on uneven floors.

- **Applications:** the powder-coated base can be paired with a solid core table top for outdoor use.

## DIMENSIONS



Ø700 Ø27 1/2"  
Ø800 Ø31 1/2"



750 29 1/2"

Eames Contract Table, ø  
700, ø 800, ø 900

Eames Contract Table,  
750 x 750

## COLOURS AND MATERIALS

### Eames Contract Tables



01  
chrome

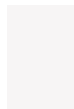

01  
white (textured)



03  
aluminium  
polished



12  
deep black  
powder-coated  
(textured)

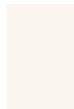

12  
white (smooth)



17  
light oak

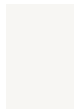

04  
white  
powder-coated  
(textured)



30  
basic dark  
powder-coated  
(smooth)

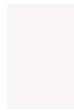

03  
white (textured)



04  
dark oak, protec-  
tive varnish

### Base

### Table top (Contract & Side Tables)



The Vitra Configuration System (VCS) software contains comprehensive information on all Vitra products and assists you in the preparation of plans and offers. VCS is available through your sales representative or at [vcs@vitra.com](mailto:vcs@vitra.com).

Planning data, further information and illustrations can be found on the Vitra extranet for architects: [www.vitra.com/extranet](http://www.vitra.com/extranet). To verify your colour selections, please order the Vitra Colour and Material Sample Box.





# Eames Segmented Tables Meeting

**vitra.**

Charles & Ray Eames, 1964



**Eames Segmented Tables Meeting**

In 1964, Charles and Ray Eames developed a system of base elements that enables many different table sizes and shapes, resulting in the elegant Eames Segmented Tables. Due to the versatility of this system, Vitra not only offers six standard table sizes but can also accommodate individual requirements and provide customised solutions.

The Segmented Tables can be equipped with power and data connections as well as wireless charging technology; cables are concealed in the base columns.

## **Materials**

- **Table top:** HPL high-pressure laminate surface (25 mm) with black edge; or oak veneer, light or dark (25 mm), with flat veneer edge.
- **Base:** components for segmented base include legs, spreader connectors, spreaders, columns and spiders. Legs and spreader connectors made of die-cast aluminium, polished, chrome finish or powder-coated; columns and spreaders made of steel, chrome-plated or powder-coated; spiders made of die-cast aluminium, powder-coated.

**DIMENSIONS**

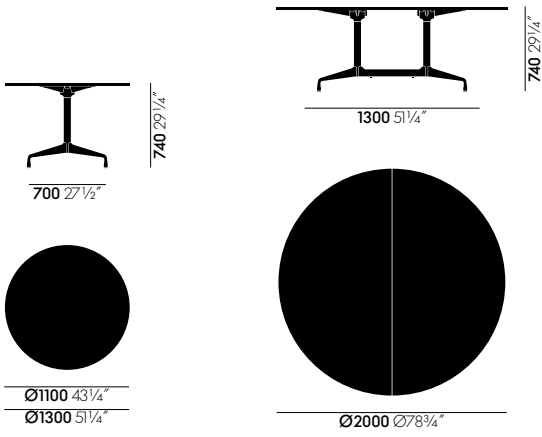

**Eames Segmented Table,**  
 ø 1100, ø 1300

**Eames Segmented Table Meeting,**  
 ø 2000

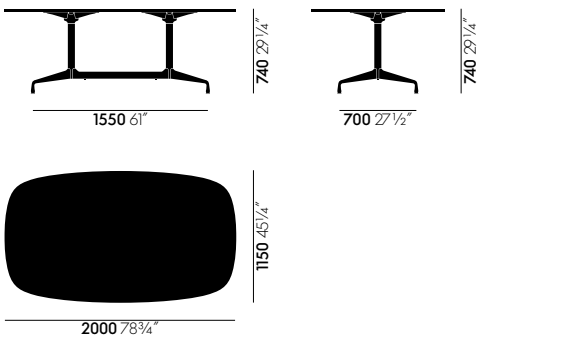

**Eames Segmented Table Meeting,**  
 2000 x 1150

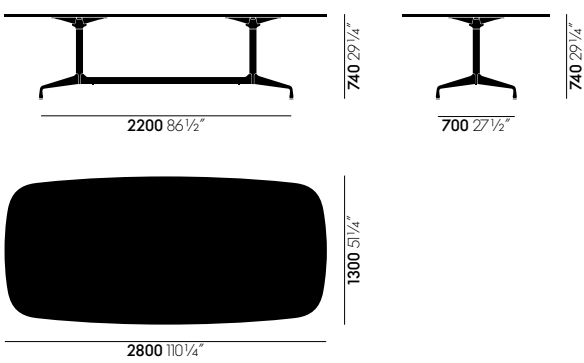

**Eames Segmented Table Meeting,**  
 2800 x 1300

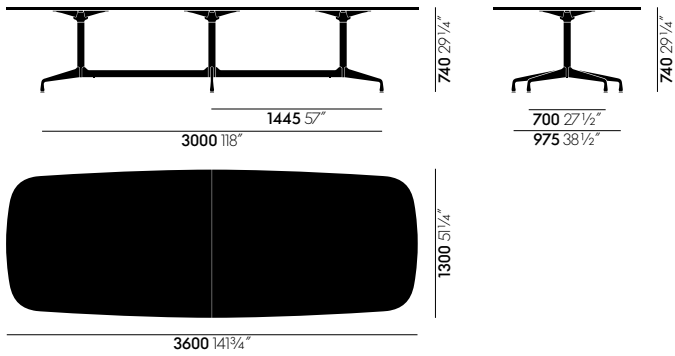

Eames Segmented Table Meeting,  
3600 x 1300

## COLOURS AND MATERIALS

### Eames Segmented Tables Meeting

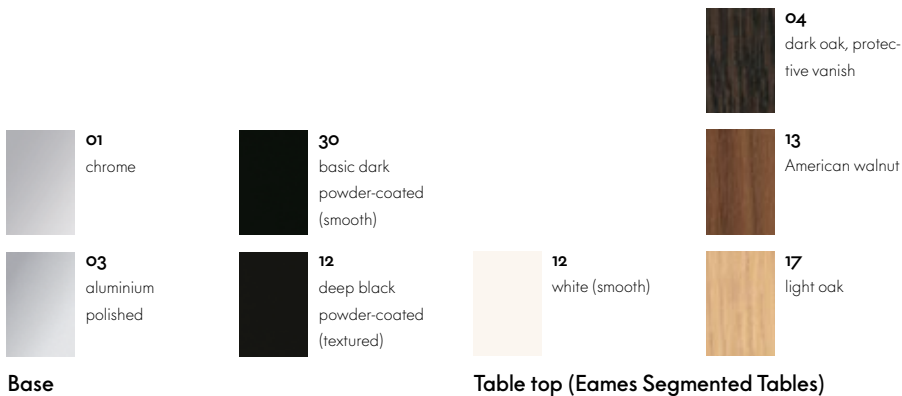

The Vitra Configuration System (VCS) software contains comprehensive information on all Vitra products and assists you in the preparation of plans and offers. VCS is available through your sales representative or at [vcs@vitra.com](mailto:vcs@vitra.com).

Planning data, further information and illustrations can be found on the Vitra extranet for architects: [www.vitra.com/extranet](http://www.vitra.com/extranet). To verify your colour selections, please order the Vitra Colour and Material Sample Box.

